

**USER'S MANUAL**  
**DC FREEDOM 100 - 100 LITRES / HOUR – 12 or 24 V**



# **DESSALATOR**

Technical and Sales Departments :  
Z.I des 3 Moulins – 282 rue des Cistes “Euro 92 – Bât. D – rue des Cistes  
06600 ANTIBES - FRANCE

Tel: (33) (0)4 93 95 04 55

Fax: (33) (0)4 93 95 04 66

e-mail: [dessalator@wanadoo.fr](mailto:dessalator@wanadoo.fr)

Web site: [www.dessalator.com](http://www.dessalator.com)

Version A5

## CONTENTS

1. Components	page 1
2. How to install the desalinator:	
Sea water inlet	page 2
Motor unit	page 3
Membrane unit	page 4
Control panel	page 5
3. Starting the Dessalator®	page 6
4. Directions for use (membranes)	page 7
5. Maintaining	
5.1 Maintaining and 5.2 Rinsing the membranes	page 8
5.2 Rinsing the membranes	page 9
5.3 Sterilizing the membranes	page 10
5.4 High pressure pump	page 10
6. Spare parts and accessories	page 11
<b>Appendix:</b>	
A1: Reverse osmosis	page 12
A2: How to assemble the HP connectors	page 13
A3: Sterilizing cartridge – Instructions for use	page 14
A4: Manual rinsing	page 15
A5: Troubleshooting	page 16
A5: Troubleshooting – Led indicator	page 17

# Installation Diagram DC FREEDOM D100 12 or 24V

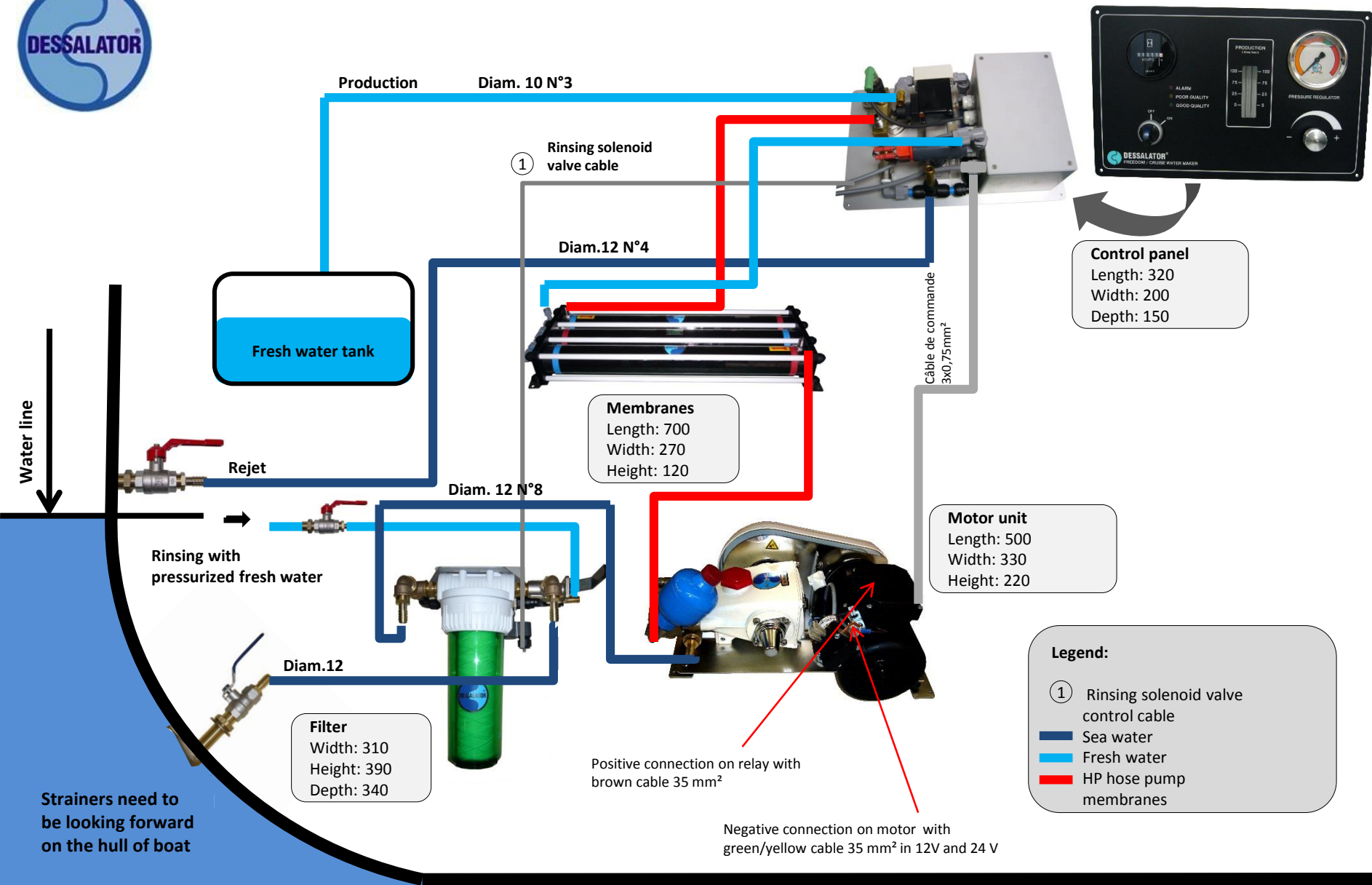

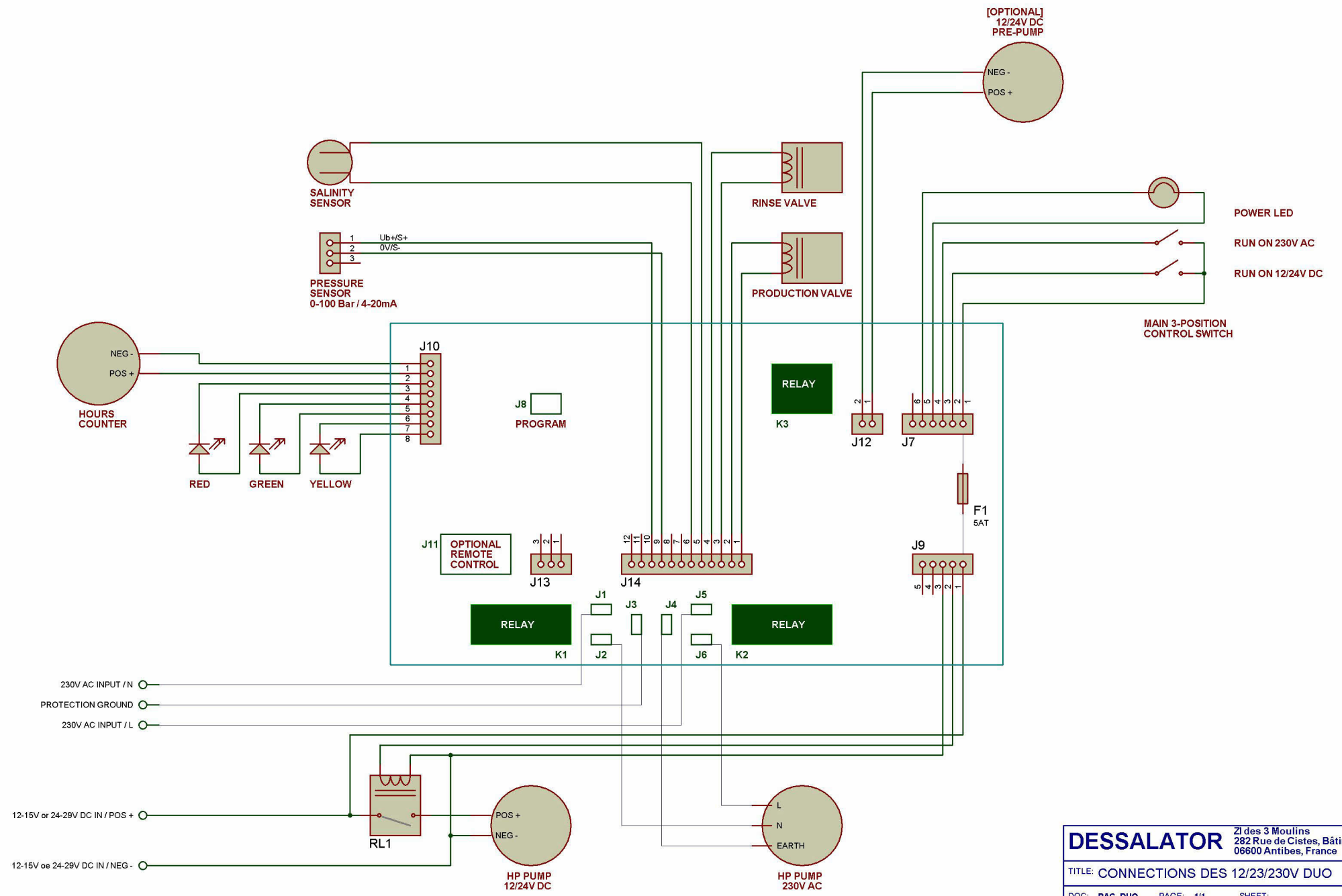

**DESSALATOR** Zi des 3 Moulins  
282 Rue de Cistes, Bâtiment Euro 92  
06600 Antibes, France

TITLE: CONNECTIONS DES 12/23/230V DUO

DOC: RAC\_DUO PAGE: 1/1 SHEET:  
REV: A DATE: 04/12/10 AUTHOR: VAK

GREENTRONICS BV - THE NETHERLANDS

# 1. Components supplied with the Dessalator®:

Version A5



## Hull valve:

It must be located the lowest possible in the boat, to the back for a motor yacht or in the centre near the keel for a sailing boat.

The hull valve strainer filters out the larger particles at system entrance.



## Pre-filter:

It must be located the nearest possible to the hull valve and be compulsory under the waterline. If not possible, there is a solution: Install a LP pump (optional).

The pre-filter filters out solid particles down to 5 µm at the motor unit inlet. It is supplied with wrench.

For automatic rinsing an electro-valve is mounted.



## Motor-Pump unit:

It must be located compulsory under the waterline

The motor-pump unit is comprised of the 12 or 24 V motor and a high pressure pump.



## Membrane unit::

The membrane unit includes 3 membranes 2521 assembled in a compact frame.

According to the model, a fuse or a circuit breaker is supplied.



## Control panel:

includes a HP gauge, a flowmeter, an on/off switch, a pressure adjustment knob, an operating time meter, 3 indicator lights.

## Pipes and hoses supplied by Dessalator®:

- High pressure pipes pump/membranes and membranes/control panel (2 pipes and 4 special connectors)
- Water production pipe membrane / control panel.

## Additional hardware needed for assembly:

- Miscellaneous screws (including Parker)
- Stainless jubilee clips Ø 10 and Ø12
- Assortment of plastic rings (tie wraps)
- Teflon tape or insulating water proof tape
- Silicon Rubson mastic, Sicaflex or equivalent
- Ribbed insulating pipe for cables and HP tubes
- Tricoflex hoses Ø 10 and Ø 12
- Power cable: 50mm<sup>2</sup> for the 12V and 20mm<sup>2</sup> for the 24V
- Various tools (electric drill, saw, ...)

## 2. How to install the watermaker:

### 2.1 Sea water inlet



#### Sea water inlet valve:

The strainer should be positioned as low as possible below the waterline and as far as possible from the deck waste outlet. Drill the hull  $\varnothing$  21mm. The grooves on the strainer should be facing forward (towards the bow) for maximum water intake when the boat is moving forward. Please seal watertight with Rubson mastic or Sicaflex and ensure that the immersed part is painted with underwater grade paint.

The hull valve should be accessible for maintenance. Make the valve / strainer and valve / hose connector watertight using 577 Loctite or Teflon tape.



#### Cartridge pre-filter:

The pre-filter should also be positioned as low as possible below the waterline and it should remain accessible. The mounting bracket is reversible, which facilitates the height positioning. The hose connection must be done with 12mm inner diameter Tricoflex for all the sea water circuit and the pressurized rinsing. Don't forget to place two stainless steel collars on each connection. 5cm space should be left below the filter body to allow the filter basin to be removed. A wrench is supplied to dismantle the filter. The fresh water pressurized rinsing must be connected to the output of your board pump. An electro-valve is mounted on the output (diam. 12) for automatic rinsing. It can be connected under a sink, a wash basin or on the way of pressurized cold water hoses. The valve handle must be positioned to the front when the water maker is working. For a manual rinsing, please move the valve handle to the back. When replacing the filter cartridge, please check that the O-ring seal for the basin is secure and that the bleeder screw is tightened and fill the circuit with fresh water again for 3 to 4 minutes, put then the handle to the front.

#### Connections:

Hull valve / three-way valve, Pre-filter / pump, Fresh water / three-way valve, rinsing electro-valve

The sea water inlet valve should be connected to the pre-filter using a tricoflex hose of inner  $\varnothing$  12mm, for sea water circuit and rinsing under pressure. Mount two jubilee clips at each joint, with their tightening heads positioned diametrically opposite on the hose. Connect the pressurized fresh water from the water outlet to the three-way valve. This connection can be made under a sink, wash basin or anywhere on the length of the pressurized fresh water pipe. When operating in sea water mode, the valve handle should be positioned in line with the filter (see photo above).

#### Recommendation:

If the pipe must pass through dividing walls or touch sharp edges, use an insulating pipe or tube superior to the pipe diameter to protect it against wear and friction.

## 2. How to install the desalinator:

### 2.2 Motor unit:



The HP motor unit should be installed as low as possible in the boat in a horizontal position and it must be protected from water spray as much as possible. The unit is mounted using two brackets under the two motors leaving a few centimetres clear space around the unit, to get sufficient air circulation space for motor cooling. The connection between the prefilter<sup>1</sup> outlet and the inlet to the low pressure side of the pump<sup>2</sup> is in Tricoflex hose of  $\varnothing$  12mm with doubled stainless jubilee clips at each joint.

The HP head<sup>3</sup> of the pump is connected to the membrane inlet (red mark) through an HP pipe, cut to the appropriate length (see installation of connectors appendix A2).

Apply a little liquid Loctite or nut seal on the male and female cones before joining.

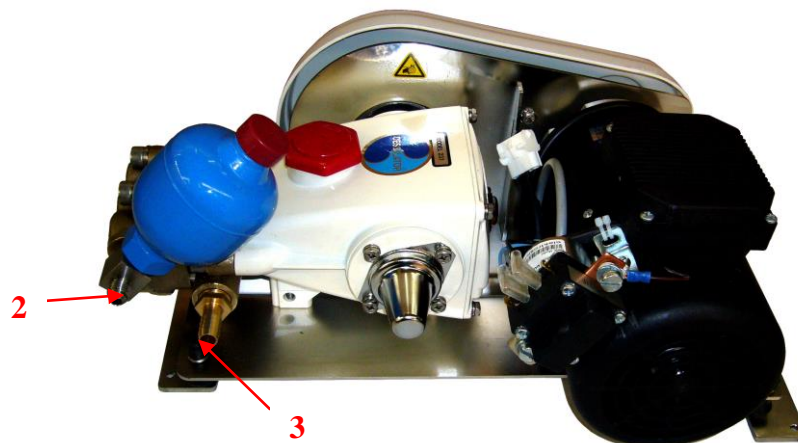

### 2.3 Electrical connections:

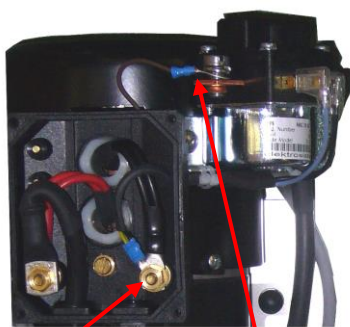

3 :Negative battery cable

4 : Positive battery cable. Please connect a fuse holder to this cable.

**CAUTION: POWER SUPPLY SHOULD BE SWITCHED OFF BEFORE WORK IS CARRIED OUT.**

When connecting the 12 or 24V motor ensure that the polarity is correct: positive (brown wire<sup>3</sup>) on the relay and negative (yellow wire<sup>4</sup>) on the 12 or 24V motor. Depending on the voltage install a 12V fuse holder (supplied) or a 24V circuit breaker (supplied) on the positive cable. Ensure that the cable is of sufficient diameter: 50mm<sup>2</sup> for the 12V or 35mm<sup>2</sup> for the 24V. The Dessalator control cable is 5m long and is equipped with a plug with a pin locator system. The Dessalator® can only be operated when the power cable is connected to a DC supply.

## 2. How to install the desalinator:

### 2.4 Membrane unit

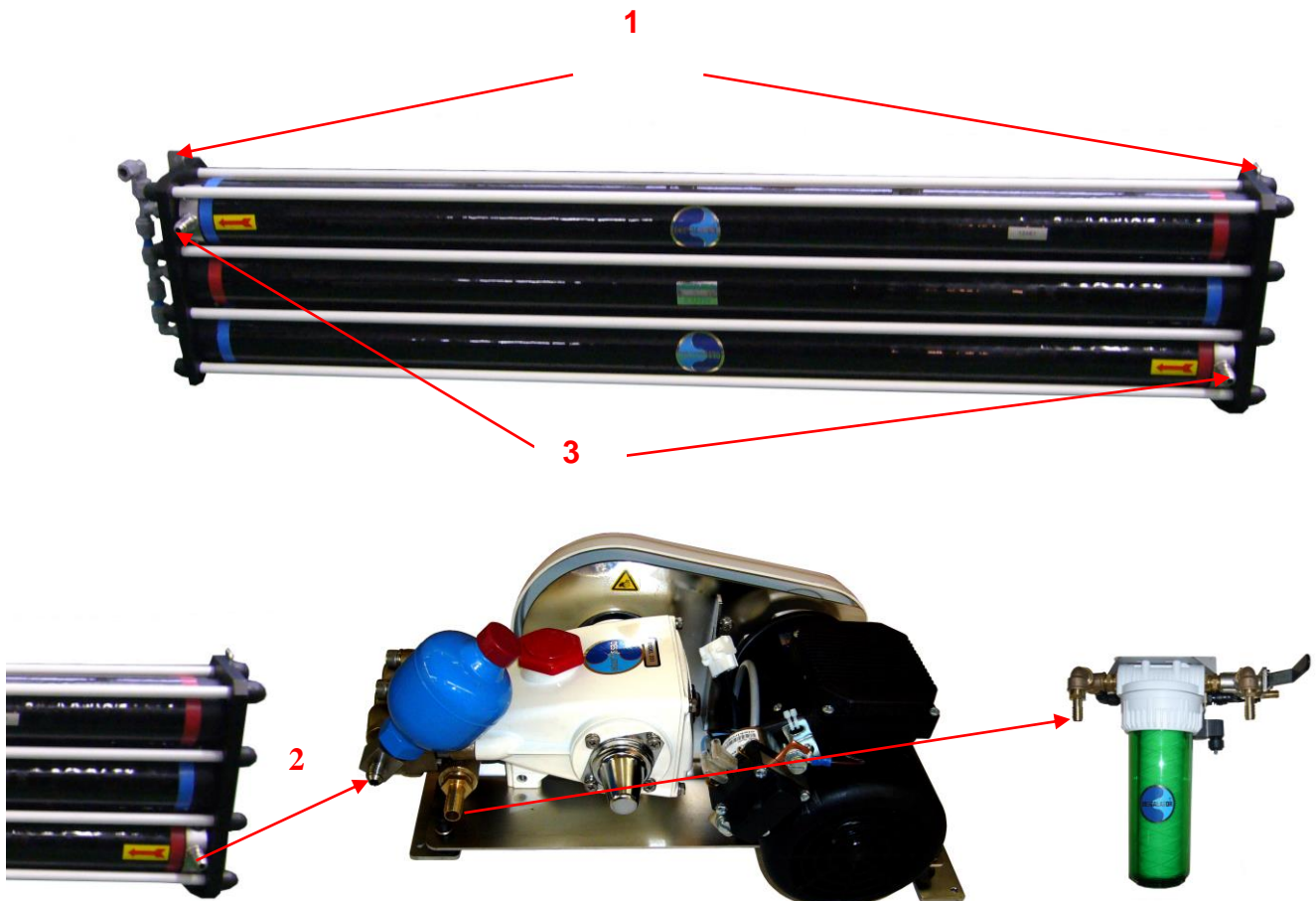

The membranes can be installed horizontally, preferably flat or on a wall support. They are mounted using 8 Parker screws in *stainless steel brackets*<sup>1</sup>. As the hose from the HP pump<sup>2</sup> vibrates, it is preferable to install the hose with an insulating tube. The HP connectors should be installed strictly in accordance with the instructions (Appendix A2). Apply a little loctite or nut seal to the two male and female cones before tightening.

Recommendation: To facilitate the connection<sup>3</sup>, it is possible to rotate the heads through 90° by unscrewing the grey production connectors. Remove the nut covers and loosen the 12 nuts maintaining the unit. Remove the rod to obtain access and rotate the membrane head using a box wrench to join the stainless steel connector. Reinstall the rod and tighten the assembly.



## 2. How to install the desalinator:

### 2.5 Control panel:

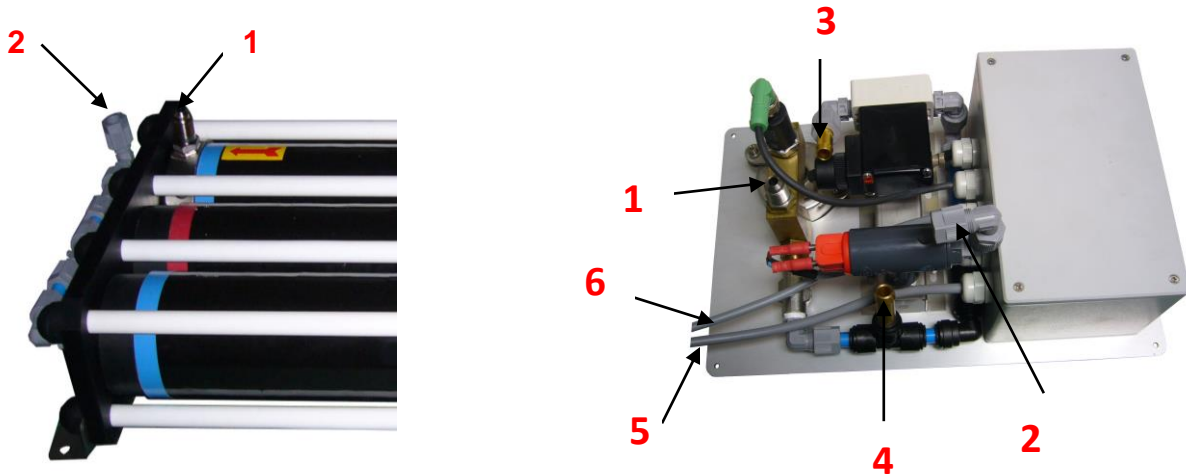

The control panel must be mounted on a vertical surface as close as possible to the motor / pump unit and to the membranes. Leave space behind the panel to facilitate the connections. It is recommended that it is installed at the bottom or on the sides of cupboards, under chart table or main cabin seats, on the front panel of a rear bunk, ...

The panel has the following water connections:

- HP hose<sup>1</sup>
- Production hose exiting the membranes (blue hose)<sup>2</sup>
- Production hose from panel to tanks<sup>3</sup>: a 10mm inner  $\varnothing$  Tricoflex hose will be required which must be connected either to the fresh water tanks or to the distribution manifold on the fresh water unit inlet provided there is no constricting valve on the fresh water tank outlet.
- A Tricoflex waste outlet inner  $\varnothing$  12mm hose<sup>4</sup> will also be required which can be connected to a sink, wash basin or cockpit water drain, to avoid having the hull redrilled. If this is not possible, remember to open the outlet valves before using the Dessalator.

Electrical connection:

- The 12 or 24V motor power cable<sup>5</sup> with a connector<sup>5</sup> and pin location system is connected to the cable exiting the 12 or 24V motor.
- The solenoid valve is connected with cable<sup>6</sup>.

### 3. Starting the Dessalator®:

1. Ensure the valves are open before starting up the desalinator (Hull valve and waste outlet valve if relevant)
2. **To be done compulsory:**  
For the first use, after the replacement of the filter, when lifting the boat out of the water or for a long period of not using your water maker, please fill the circuit with fresh water: put the handle valve on the pre filter to the back; this operation should be done for 3 or 4 minutes, water maker stopped and pressure captor open (fully anti-clockwise). Once the circuit is full of fresh water put the valve handle of the pre filter to the front.
3. It is important to take account of the ampere capacity of the batteries and of the working duration: for a use without any risk, it is compulsory to start the motor of the boat.
4. To start the water maker, the pressure regulator must be open. Switch on.
5. Turn the pressure regulator dial to the right until the HP gauge reading is in the orange zone then gradually adjust until the needle reaches the beginning of the green zone. Check that the pressure remains constant. The purpose of this operation is to remove air from the system and to obtain a more constant pressure while the water maker is running.
6. Fresh water quality and flow into the tank is automatically monitored by the electronics board.
7. If pressure becomes too high the water maker will cut out and the red indicator will light up. If this occurs, reduce pressure, switch off and restart the water maker.
8. To shut down the water maker: switch off then reduce pressure.
9. To shut down with rinsing, please see page 8 and 9.
10. If the water maker is not used for extended periods of time it should be rinsed preferably once a month. If not, the membranes will have to be sterilized for the storage (for 6 months).

*Note: Fresh water production depends on the temperature of the sea water and on the cleanness of the 5µm pre-filter.*

## 4. Directions for use:

### MEMBRANES DELICATE COMPONENTS

Reverse osmosis membranes must be carefully maintained as they are the most delicate elements of the system. We recommend that the maintenance instructions are carefully followed to prevent the membranes from damage and to ensure the guarantee is not invalidated. Maximum production capacity of the desalinator is achieved with a sea water temperature of 25°C. The functioning of the membranes will vary depending on the temperature of the sea water and the sailing area. Output drops by approximately 2.5% to 5% for each degree below 25°C.

#### Extreme temperatures:

The membranes should not be exposed to temperatures below 0°C. Overpressure due to expansion caused by freezing can rupture the membranes and prevent the salt from being filtered out. The membranes must not be exposed to temperatures above 60°C as high temperatures may also prevent salt from being removed.

#### Drying out of the membranes:

The membranes should be permanently immersed in liquid either sea water before treatment, fresh water provisionally stored or sterilizing liquid if the desalinator is not used for extended periods of time (See sterilization methods appendix A3). Sterilizer is effective for six months and must be replaced after this period of time.

#### Recommendations for use:

The various quality and salinity grades of sea water affect both membrane efficiency and the working of the desalinator in Marinas. **The system is not recommended for use in muddy or polluted water (briny water, river, Red Sea)**, which can clog the pre-filter and damage the membranes. However, if the desalinator has to be used in such conditions only run it for very short periods, as soon as clean sea water becomes available rinse the membrane and run the system without pressure for 30 minutes with the pressure regulator open.

## 5. Maintenance:

**CAUTION: IN FREEZING CONDITIONS, PLEASE EMPTY THE FLOWMETER TUBE ON THE CONTROL PANEL BY DISCONNECTING THE PRODUCTION HOSE AND BLOWING OR INJECTING AIR INTO THE HOSE, PROTECT YOUR MEMBRANES WITH BLANKETS.**

### 5.1. Maintaining the membrane

After 1,000 working hours, it is normal that the flow lowers between 10 and 15%. If more, you should think of replacing the membranes.

- The volume of production of your watermaker can be made over the first 24 to 48 hours of operation. If the drinking water produced falls below the normal working specifications (sea water containing a TDS of 35,000 ppm, a sea water temperature of 25°C, and pressure of 65 bars), and if production is not improved by rinsing the membrane, then the membrane has to be replaced.
- Please take into consideration that the volume of drinking water produced is dependent on ideal sea water temperature and on pressure in the system. Therefore, if the volume of drinking water produced falls it does not necessarily mean that the membrane need to be replaced.

### 5.2. Rinsing the membranes

Once a week, the water maker needs to be flushed with fresh water before using it to make fresh water. There is no need to flush it with fresh water after each use, as this is just a waste of water that are taken from the boat's tank.

There are 2 methods to flush the system: manual and automatic.

Both systems are using the water that are in the tanks of the boat, and there is no use in water from the dock or a connection of any hose from a source outside the boat.

Remember: The biggest enemy of the membranes is fresh water.

Fresh water should be always used with no pressure when going through the system (pressure dial turned all the way anti clockwise) and the system should always run with no pressure after a fresh water flush to dump all the fresh water that are in it, before making freshwater from sea water (also with the pressure dial all the way anti clockwise).

When running the watermaker with the dial all the way anti clockwise, it will shut it self down automatically after 1 minute. Only then, the watermaker is ready for use.

## 5. Maintenance:

### **Manual Flush**

Next to the pre filter there is a valve. The valve is connected to the fresh water system of the boat and turning it, will automatically start the boat's water pump and a flow of fresh water from the tank to the water maker.

1. **Don't turn the water maker ON**. Leave it on it's OFF position.
2. Turn the pressure dial all the way anti clockwise.
3. Turn the valve of the fresh water intake, which is located next to the filter, for 2 minutes. The boat's water pump will start and fresh water will run through the water maker.

### **Automatic Flush**

After using the water maker, don't switch it off.

While the water maker is still running, turn the pressure dial all the way anti clockwise. The water maker will stop making water and will automatically start the flushing process. The green and orange lights on the control panel will turn on, which indicates that flushing is in process. This should take 30 seconds and will stop automatically. The green and orange lights will shut off and the only indicator will be the blue flashing light on the ON/OFF button, to remind you to shut the water maker OFF.

The automatic flush is a better way to flush the system since it's not only flushes the sea water out, it also back wash the pre-filter and dumps all the dirt and debris that accumulated in the filter's housing, back to the sea, through the sea water intake.

### **DON'T FORGET!!!**

After each system flushing, before using the water maker you need to:

1. Make sure the pressure dial is turned all the way anti clockwise.
2. Turn the water maker ON and let it run with no pressure for 1 minute until the red alarm light comes on. This is the time needed for the sea water to replace all the fresh water that are in the system, before running pressurized sea water through the membranes.

**RUNNING FRESH WATER IN HIGH PRESSURE THROUGH THE MEMBRANES WILL**  
**DAMAGE THE MEMBRANES!!!**

## 5. Maintenance:

### 5.3. STERILIZING THE MEMBRANE

#### **When should the membrane be sterilized?**

Normally, regular monthly rinsing of the membrane may be all that is required to maintain the membrane. If this is not possible, sterilization will be necessary. A sterilisation procedure should be carried out every six months.

#### **Membrane sterilizing procedure:**

1. Manual method: Thoroughly rinse the desalinator with fresh water for 10 minutes, using the three-way valve on the pre-filter. This procedure should be followed while the machine is idle. Pour the sterilizer (entire packet contents) into a bucket containing 8 litres of water. Disconnect the sea water inlet hose and immerse it in the bucket. Run the desalinator without increasing pressure until the bucket is empty. When the bucket is empty and the procedure is completed, the hose can be reconnected. If not, see number 3.
2. The sterilizing procedure can also be carried out using a garden spray: Pour the entire packet contents of sterilizer into a bucket containing 8 litres of fresh water and mix thoroughly. Fill the spray bottle with this mixture and spray the sterilizer into the water maker inlet, at a spray pressure of 3 to 4 bars. If not, see number 3.
3. Sterilizing cartridge ST2:  
We have developed a sterilizing cartridge which makes this procedure very simple and easy. Cartridge instructions are given in appendix A3. Before using the desalinator again simply rinse with fresh water for a few minutes using the three-way valve on the pre-filter and all traces of the sterilizer will be removed.

### 5.4. HP Pump

The HP pump is half filled with oil to the indicated level on the gauge. Normally no additional oil is needed throughout the life of the water maker. However, if refilling is necessary, use multi grade oil 15W40 and do not exceed the indicated level (in the middle of the red mark on the gauge which is on the back of the pump to the opposite of the pump head).

**BEWARE:** the sticker located on the red oil filling cap of the HP pump is there only for the shipment: it must be removed before use.

## 6. SPARE PARTS AND ACCESSORIES

### Spare parts

Dessalator® systems are very reliable, hardwaring and do not generally require expensive services. Nevertheless an accident is always possible (running without enough water, accidental overpressure, impact,...).

Should the need arise, we supply spare parts and maintenance accessories:

- 5µm 10 ft filter
- driving belt
- motor relays
- production solenoid valve
- HP pump seals and valves
- HP hose (sold by meter)
- Connector for HP tube
- Flowmeter tube

### Accessories:

- Sterilizing cartridge ST2
- Sterilizer bag
- Mineralizing cartridge

## **APPENDIX – A1**

### **Reverse Osmosis**

#### **What is the reverse osmosis principle used in your desalinating system?**

Sea water is forced at high pressure through the membranes which act as “molecular sieves”, only allowing pure fresh water to pass through. Most dissolved solid particles will not penetrate the membrane. This waste, along with the remaining saline solution, will flow on the surface of the membranes and will be rejected. Not all particles dissolved in sea water can be eliminated. The system is designed to reject 99% of the TDS (Totally Dissolved Solids); approximately 2% of the 35,000 PPM/TDS will pass through the membrane. This guarantees drinking water with a TDS value of 500 (average). Please note that the drinking water produced by your reverse osmosis system is essentially sterile, however, your fresh water storage should be treated periodically with a slight dose of chlorine (or iodine) and it should be also mineralized to ensure it remains consumable. Pay attention not to allow pure chlorine (or a too high dose of chlorine) into the desalination system, as this could damage the device.

#### **How does your desalinator work?**

Sea water enters the inlet valve which penetrates the hull. This sea water is then routed through the 5 µm pre-filter. The filtered water is forced through the membrane by the HP pump (operating pressure 60 to 65 bars). The pressurised water passes through the surface holes of the membranes depositing the salt and minerals, which are then rejected into the sea with the remaining solution. The now fresh water flows over a detector which measures its salt content: If the desalination achieved is satisfactory, the three-way valve automatically directs the fresh water to the tank. If the salinity values measured by the salinity probe are too high (conductivity > 1,000 siemens), the valve will reject the water produced into the sea. The volume of drinking water being treated at any time is monitored by a flowmeter on the control panel. The production capacity of fresh water is achieved with a sea water temperature of 25°C. The output drops by approximately 2,5 to 5% for each degree below 25°C.



# APPENDIX – A2

## Installation instructions – HP Connectors

1. Screw the brass union (skirt) anti-clockwise onto the HP pipe, no more than 2.5cm. Stop where the inner threading disappears.

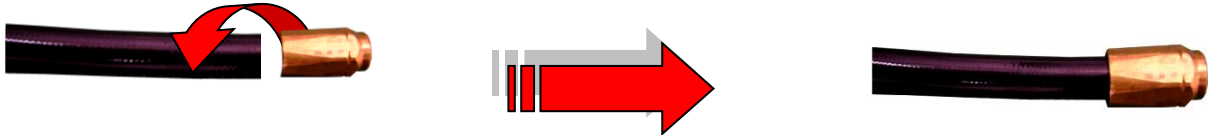

2. Insert the steel tapered end-piece into the stainless steel nut, and tighten very firmly on the male tapered union.

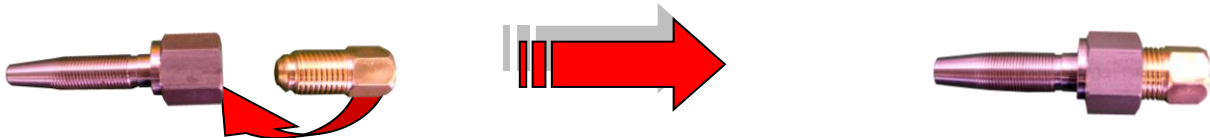

3. Lightly grease the tip of the stainless steel cone and screw it straight into the brass union. Stop where the steel threading disappears into the brass end-piece (a gap of approximately 7mm between the nut and the brass union)

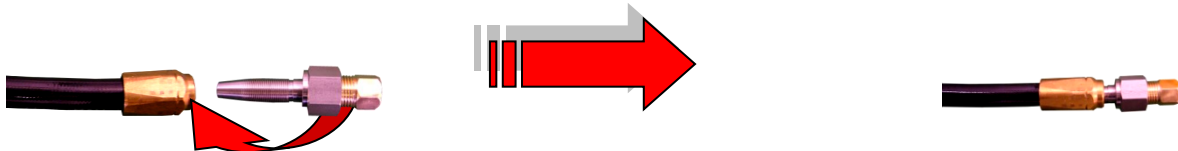

4. Unscrew the nut of the tapered adaptor. The connector is now ready for the hose from pump to membrane. We recommend using an insulating pipe to protect it against vibrations.

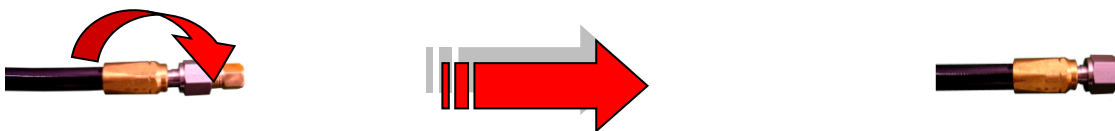

5. **IMPORTANT:** Check carefully that the end-piece does not block the hose:
  - Please don't forget to put Loctite or watertight product on the male and female cones when remounting.
  - Please check that the HP connector is not blocked up.
    - either by blowing into the hose
    - or by inserting a screwdriver to check free passage.

## APPENDIX – A3

### Sterilizing cartridge – instructions for use

The desalinator is not running:

1. Close the sea water inlet valve.
2. Open the sterilizing cartridge
3. Remove the top grid
4. Place the foam filter at the bottom of the filter
5. Pour the powder into the cartridge
6. Replace the top grid and close the cartridge
7. Check that the seal is properly positioned.
8. Dismantle the basin of the pre filter
9. Remove the 5 $\mu$ m cartridge from the pre-filter.

Remove the 5 $\mu$ m cartridge  
from the pre-filter



10. Replace with the sterilizing cartridge ST2

Replace the 5 $\mu$ m cartridge  
with the sterilizing  
cartridge ST2



11. Set the rinsing valve to pressurized fresh water and rinse, leaving a little sterilizer in the filter.
12. At this point, the desalinator must be switched off
13. The sterilisation remains effective for six months at most. (Repeat after this time as necessary).

**Caution:** Before next use, rinse the desalinator thoroughly with fresh water for 15 minutes and ensure that the sterilizing cartridge has been removed and replaced by a 5  $\mu$ m cartridge.

**BEWARE:** The ST2 cartridge is reusable.

## APPENDIX – A4

Your DESSALATOR® is equipped with an automated rinsing.  
Please find her below the procedure if you wish to rinse it manually.

### MANUAL RINSING

Your Dessalator® is equipped with an automated rinsing.  
Here below the procedure to rinse manually.

#### Manual rinsing and sterilization:

Valve handle to the back.



#### Normal position for a use with sea water:

Valve handle to the front

















## APPENDIX – A5

### Troubleshooting

PROBLEM	CAUSE	SOLUTIONS
Leak on the pressure regulator in front of the control panel	Loosened regulation cable gland	Tighten the cable gland with a 12 wrench.
Noisy HP pump.	<ul style="list-style-type: none"> <li>- Reduced water inlet or air inlet in the system.</li> <li>- Leak on pump head seals.</li> </ul>	<ul style="list-style-type: none"> <li>- Ensure correct size of hoses (diameter), clips and filters secure and filters clean.</li> <li>- Replace seals.</li> </ul>
Oil leak on HP pump	Worn seals on connecting rods	<ul style="list-style-type: none"> <li>- Replace the seals.</li> </ul>
Insufficient water flow	<ul style="list-style-type: none"> <li>- Very cold water</li> <li>- Dirty pre filter</li> <li>- Tension drop on the power cable</li> </ul>	<ul style="list-style-type: none"> <li>- Replace the pre filter</li> <li>- Recharge batteries</li> <li>- Check the connection.</li> <li>- Inadequate power cable section, reinforce cable section.</li> </ul>
Water leak under the HP head	<ul style="list-style-type: none"> <li>- Worn seals</li> </ul>	<ul style="list-style-type: none"> <li>- Replace plunger seals</li> </ul>
No pressure reading	Insufficient water	Open the hull valve and / or the rinsing valve
Pressure doesn't come up.	Dirty pump valves	Dismantle and clean the valves in the pump head

# APPENDIX – A5

## Troubleshooting: led indicator

LED INDICATOR	DESCRIPTION AND ACTIONS
  	<b>System check at startup</b> When these LEDs remain on, please open the regulator (-) to release pressure
	<b>Pumps started, waiting for production pressure</b> Slowly turn the pressure regulator clockwise (+) until the manometer is in the 'green' zone.
	<b>Production pressure ok, waiting for good quality</b> Please wait, when the water-quality is good, the machine will automatically start producing water
	<b>Producing water</b> Water quality is good, producing potable water
 	<b>Automatic Rinsing</b> Please wait, automatic rinsing takes 30 seconds to complete
 	<b>Poor pressure</b> Pressure is too low. Slowly turn the pressure regulator clockwise (+), make sure it is not completely closed
 	<b>Alarm 1-1: Time-out pressure too low</b> Did the pump start at first? Then check sea-water intake, pre-filters and pre-pump. Re-start and retry
 	<b>Alarm 1-2: Power failure on pressure sensor</b> If the machine goes to this alarm after powering up: possible sensor failure or system voltage too low
	<b>Alarm 2-1: Pressure too high; STOP button pressed (optional)</b> Switch off, open regulator completely (-) and restart the machine

v1.1-020812

 LED is FLASHING

 LED is ON